

**08**

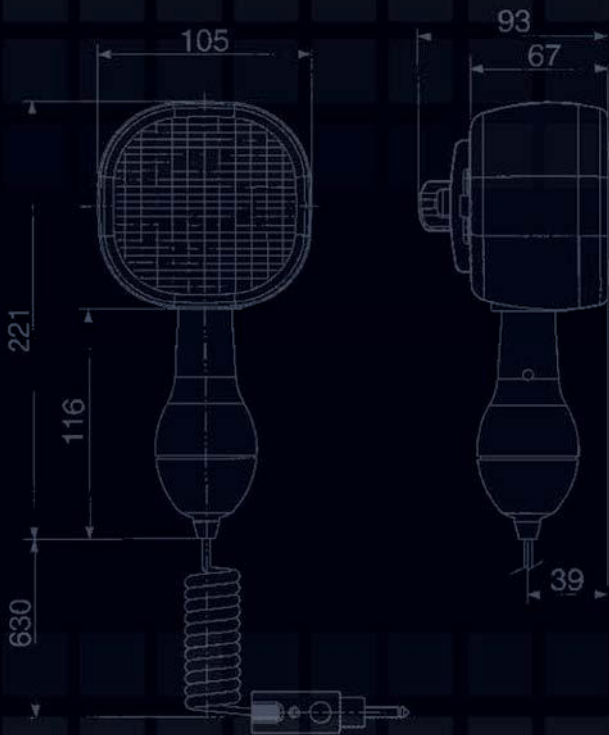

## LAMPADE D'ISPEZIONE E PROLUNGHE

INSPECTION LAMPS  
AND EXTENSIONS

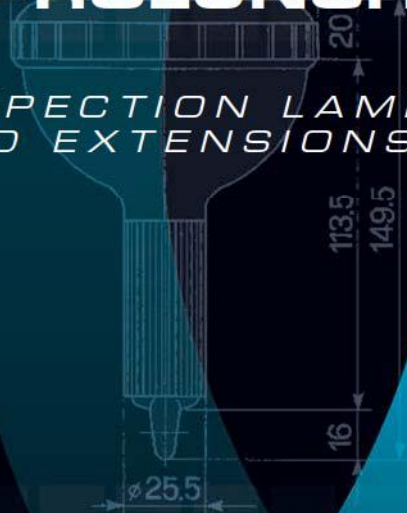





**08**

## **LAMPADE D'ISPEZIONE E PROLUNGHE**

*INSPECTION LAMPS  
AND EXTENSIONS*

- **Lampade d'ispezione e prolunghe**
- **Inspection lamps and extensions**



Prolunga per lampada d'ispezione  
Extension for inspection lamp

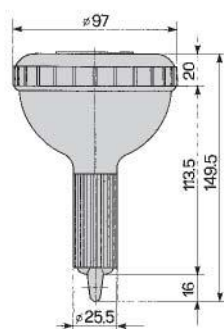

P/N	MT.	SPINA PLUG
08.001.000	5	FIAT
08.009.000	5	BOSCH

Prolunga per lampada d'ispezione  
Extension for inspection lamp



P/N	MT.	SPINA PLUG
08.004.000	3	
08.005.000	5	
08.007.000	15	
08.008.000	20	

Lampada d'ispezione con spina per accendisigari  
Inspection lamp with plug for lighter

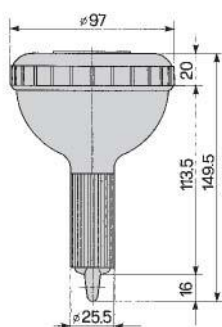

P/N	MT.	CONNESSIONE CONNECTION
08.013.000	4	Accendisigari o presa DIN Cigarette plug or DIN socket

Prolunga per lampada d'ispezione  
Extension for inspection lamp



P/N	MT.	CONNESSIONE CONNECTION
08.016.000	5	Accendisigari o presa DIN Cigarette plug or DIN socket
08.017.000	15	Accendisigari o presa DIN Cigarette plug or DIN socket

Proiettore compatto d'emergenza  
Emergency inspection lamp  
Lampada - Bulb H3 24V-55W

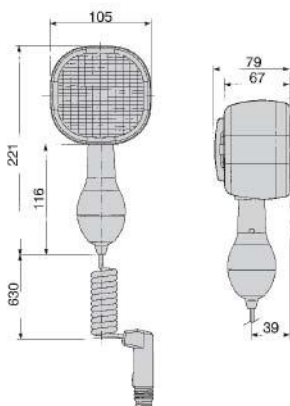

SENZA INTERRUTTORE  
WITHOUT SWITCH



CON INTERRUTTORE  
WITH SWITCH

P/N	INTERRUTTORE SWITCH	MT.	CONNESSIONE CONNECTION
05.648.000		3	Accendisigari o presa DIN Cigarette plug or DIN socket
05.649.000	X	3	Accendisigari o presa DIN Cigarette plug or DIN socket

Proiettore compatto d'emergenza  
Emergency inspection lamp  
Lampada - Bulb P21W 24V-21W

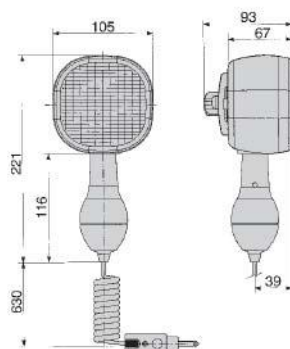

CON INTERRUTTORE  
WITH SWITCH

P/N	INTERRUTTORE SWITCH	MT.	CONNESSIONE CONNECTION
05.1231.0000	X	3	Spina unipolare Single pole plug

Proiettore compatto d'emergenza  
Emergency inspection lamp  
Lampada - Bulb P21W 24V-21W

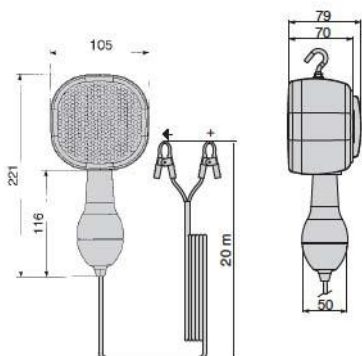

SENZA INTERRUTTORE  
WITHOUT SWITCH

P/N	INTERRUTTORE SWITCH	MT.	CONNESSIONE CONNECTION
05.0840.0000		20	Pinzette Clips